



People Helping People Build a Safer World®

Methods of Venting Plumbing Fixtures and Traps in the 2018 IPC

Installation, Flexibility and Opportunity for Savings



Lee Clifton, Senior Director of PMG Resources, Government Relations

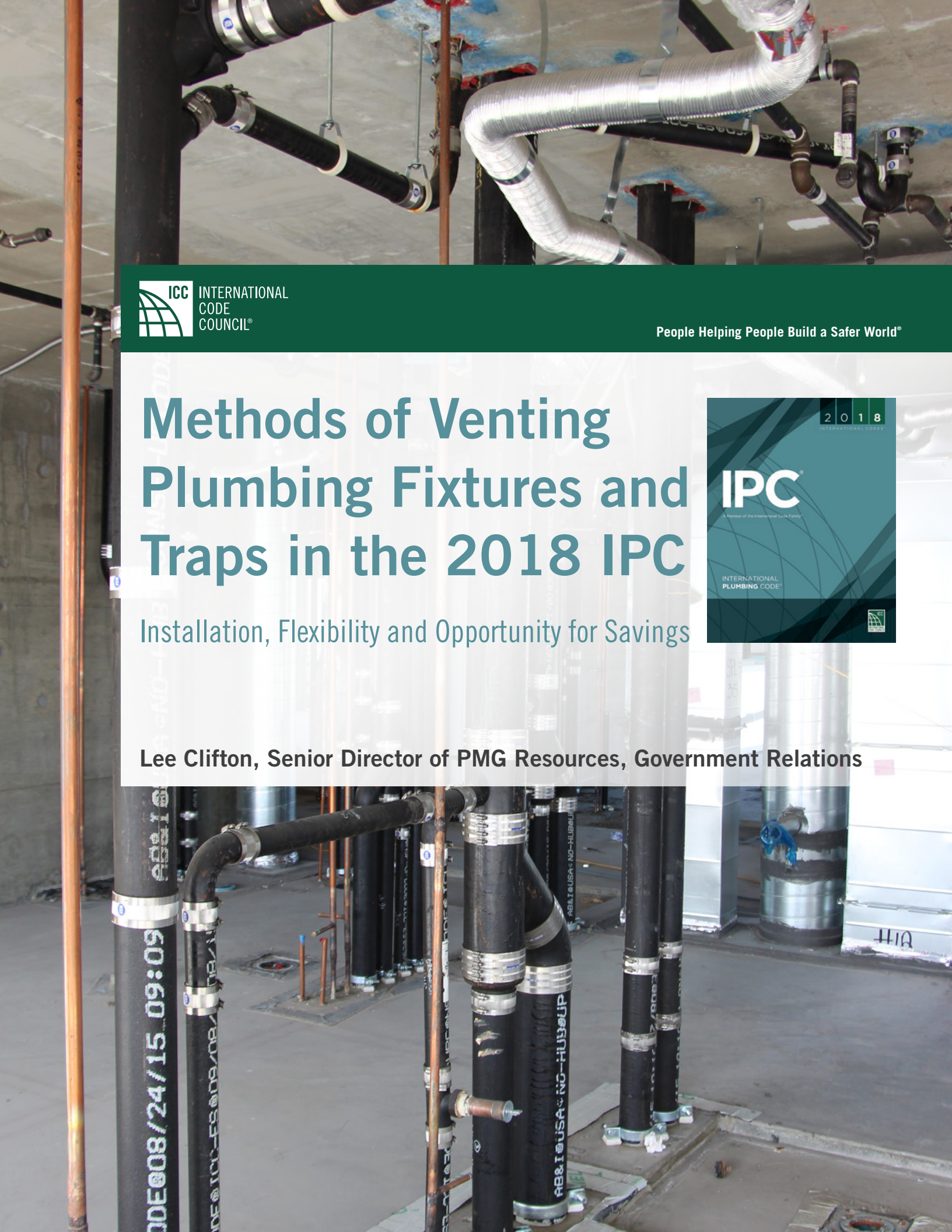

Chapter 9 of the *International Plumbing Code*® (IPC®) describes a variety of methods to vent plumbing fixtures and traps. The methods have been laboratory tested to determine sizing and installation requirements that provide proper venting to a drainage system. The venting methods have also been field tested, establishing a long history of satisfactory service.

In this publication, we will present the various approaches to venting that are permitted in the 2018 IPC. You will find that these venting provisions offer the installer and designer different paths to achieving an adequately vented system, which could result in cost savings along with ease of installation in different types of construction.



Chapter 9 of the *International Plumbing Code* (IPC) describes a variety of methods to vent plumbing fixtures and traps.

Three Specific Venting Methods

Section 901.2.1 of the IPC establishes that traps and trapped fixtures shall be vented in accordance with one of the venting methods specified in this Chapter. Section 904.1 requires the vent system serving each building drain to have at least one vent pipe that extends to the outdoors.

The most widely used method is commonly referred to as a conventional venting system. **Table 909.1** (below) provides the maximum distance allowed for a vent in relation to the trap. A fixture vent connected in this manner is called an individual vent. These individual vents are sized according to Section 906.2. Here we find that the vent must be at least one-half the diameter of the drain served, but in no case less than 1¼ inches in diameter.

TABLE 909.1
Maximum Distance of Fixture Trap from Vent

Size of Trap (inches)	Slope (inch per foot)	Distance from Trap (feet)
1¼	¼	5
1½	¼	6
2	¼	8
3	⅛	12
4	⅛	16

For SI: 1 inch = 25.4 mm.

Remember, the vent size is not based on the trap or fixture drain (trap arm), but the drain size that continues downstream from the point where the vent and fixture drain connect. The drain size is determined by the fixture unit load in accordance with Tables 709.1, 709.2, 710.1(1), and 710.1(2) in the IPC. Hence, if the drain size is 4 inches (102 mm), a 2-inch (51 mm) vent is required. A 3-inch (76 mm) drain would require a 1½-inch (38 mm) vent. A 2-inch (51 mm), 1½-inch or 1¼-inch (38 or 31.8 mm) drain would require a minimum 1¼-inch (31.8 mm) vent, this being the minimum size allowed.

Section 905.5 allows individual vents to merge with each other, as long as the connection is made at least 6 inches above the flood-level rim of the highest fixture served. Sizing of

the vents as they connect is again based only on the required size of the drain being served. Section 906.2 requires that vents exceeding 40 feet (1016 mm) in developed length shall be increased by one nominal pipe size for the entire developed length of the vent pipe.

It is important to know that Section 904.2 states a vent stack shall be required for every drainage stack that has five branch intervals or more. If the drainage stack is less than five branch intervals in height, a vent stack is not required because the pressure in the drainage stack is not likely to create a pressure differential at the trap seals in excess of 1 inch (25.4 mm) of water column. When required, vent stacks are to be dry and are required to connect at or near the base of the stack served to act as a relief vent for the pressures that develop in the lowest portions of the stacks.

The exception in Section 904.2 wisely eliminates an unnecessary vent to a system that already has adequate fresh air exchange assurance. Waste stack vented systems, as covered in Section 913, are already oversized to provide for adequate venting without the need for additional venting.

The code only requires stack vents for drainage stacks in Section 913.3 because the minimum required venting of each fixture has been accomplished when the system complies with the venting methods outlined in Chapter 9. A stack vent is typically used as a collection point for vent pipes so that a single roof penetration can be made.

Keep in mind that “stack vents” and “vent stacks” are distinct. See definitions in the next section.

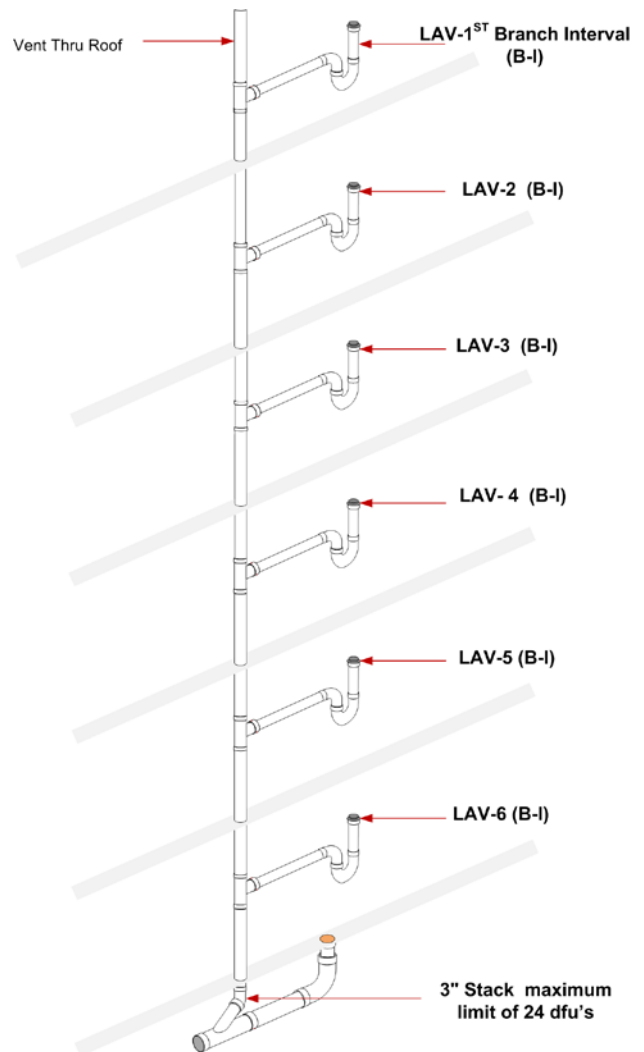
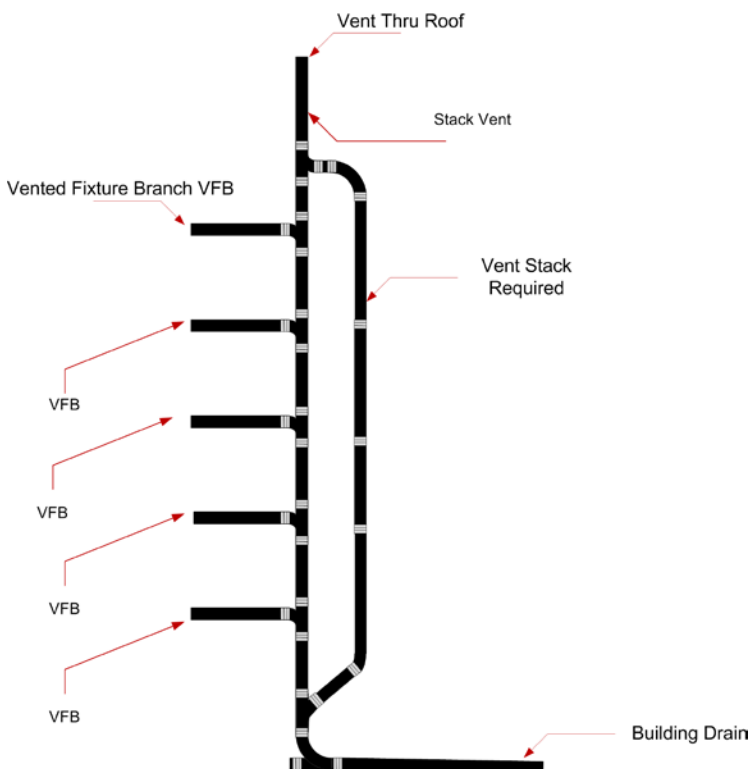

The example illustrates a typical vent stack compared with the special Waste Stack Venting system.

Definitions

Branch Vent. A vent connecting one or more individual vents with a vent stack or stack vent.

Circuit Vent. A vent that connects to a horizontal drainage branch and vents two traps to no more than eight traps or trapped fixtures connected into a battery.

Combination Waste and Vent System. A specially designed system of waste piping embodying the horizontal wet venting of one or more sinks or floor drains by means of a common waste and vent pipe adequately sized to provide free movement of air above the flow line of the drain.

Common Vent. A vent connecting at the junction of two fixture drains or to a fixture branch and serving as a vent for both fixtures.

Individual Vent. A pipe installed to vent a fixture trap and that connects with the vent system above the fixture served or terminates in the open air.

Stack Vent. The extension of a soil or waste stack above the highest horizontal drain connected to the stack.

Stack Venting. A method of venting a fixture or fixtures through the soil or waste stack.

Vent Stack. A vertical vent pipe installed primarily for the purpose of providing circulation of air to and from any part of the drainage system.

The developed length of individual, branch, circuit, and relief vents shall be measured from the farthest point of vent connection to the drainage system to the point of connection to the vent stack, stack vent, or termination outside of the building.

There are important criteria to remember when sizing a conventional venting system composed of individual fixture vents, vent stacks, and stack vents. The minimum size of an individual vent is one-half the required drain size, whereas the minimum size of the vent stacks and stack vents is one-half the size of the drain served.

The sizing criteria for stack vents and vent stacks are based on three variables:

1. The developed length of the vent.
2. The size of the stack served by the vent.
3. The total drainage fixture unit (DFU) connected to the stack.

Example A:

A 3-inch (76 mm) soil stack with a stack vent serving as the required vent extension to the outdoors, connecting to a 3-inch (76 mm) building drain, must have at least a 1½-inch (38 mm) stack vent [maximum of 102 fixture units served and a maximum 25-foot (7620 mm) developed length] in accordance with Section 906.1 and **Table 906.1**. This 1½-inch (38 mm) stack vent is the minimum size required to comply with this section because it is at least *one-half the size of the building drain*.

TABLE 906.1
Size and Developed Length of Stack Vents and Vent Stacks

DIAMETER OF SOIL OR WASTE STACK (inches)	TOTAL FIXTURE UNITS BEING VENTED (dfu)	MAXIMUM DEVELOPED LENGTH OF VENT (feet) ^a										
		DIAMETER OF VENT (inches)										
		1¼	1½	2	2½	3	4	5	6	8	10	12
1¼	2	30										
1½	8	50	150	—	—	—	—	—	—	—	—	—
1½	10	30	100									
2	12	30	75	200								
2	20	26	50	150		—	—	—	—	—	—	—
2½	42		30	100	300							
3	10		42	150	360	1,040						
3	21	—	32	110	270	810	—	—	—	—	—	—
3	53		27	94	230	680						
3	102		25	86	210	620						
4	43	—		35	85	250	980	—	—	—	—	—
4	140			27	65	200	750					
4	320			23	55	170	640					
4	540			21	50	150	580					
5	190				28	82	320	990				
5	490				21	63	250	760				
5	940				18	53	210	670				
5	1,400				16	49	190	590				
6	500					33	130	400	1,000			
6	1,100					26	100	310	780			
6	2,000					22	84	260	660			
6	2,900					20	77	240	600			
8	1,800						31	95	240	940		
8	3,400						24	73	190	729		

For SI: 1 inch = 25.4 mm, 1 foot = 304.8 mm.

^aThe developed length shall be measured from the vent connection to the open air.



Quality venting systems take careful planning

Non-Conventional Venting Methods

Proper application of these venting options can substantially reduce the amount of pipe and fittings used, while still providing proper venting. Inspectors and plumbers often overlook the opportunities afforded by these different venting methods, which have been proven to save money and may be helpful in areas where conventional venting methods may be difficult to install.

Island Fixture Venting

This is a specific method for venting an island sink, one limited to sinks and lavatories. Residential kitchen sinks with a dishwasher waste connection, a food waste grinder, or both, in combination with the kitchen sink waste, shall be permitted.

The island fixture vent shall connect to the fixture drain as required for an individual or common vent. The vent shall rise vertically to above the drainage outlet of the fixture being vented before offsetting horizontally or vertically downward. The vent or branch vent for multiple island fixture vents shall extend to a minimum of 6 inches (152 mm) above the highest island fixture being vented before connecting to the outside vent terminal.

The vent located below the flood level rim of the fixture being vented shall be installed as required for drainage piping in accordance with Chapter 7, except for sizing. The vent shall be sized in accordance with Section 906.2. The lowest point of the island fixture vent shall connect full size to the drainage system.

The connection shall be to a vertical drain pipe or to the top half of a horizontal drain pipe. Cleanouts shall be provided in the island fixture vent to permit rodding of all vent piping located below the flood level rim of the fixtures. Rodding in both directions shall be permitted through a cleanout.

As you can see from the diagram for this installation, this venting method provides for a free flow of air where liquid is not being trapped in the lowest portion of the vent, because of its connection to the drain. This method will work well in a crawl space or underground application.

Relief Vents—Stacks of More than 10 Branch Intervals

This venting method requires a relief vent equal to the size of the vent stack it connects with for buildings exceeding 10 branch intervals. A relief vent must be located at every 10 branch intervals, measured from the highest horizontal drainage branch, and then calculated downward to the base of the stack.

The lower end of the relief vent is connected to the soil or waste stack below the level of

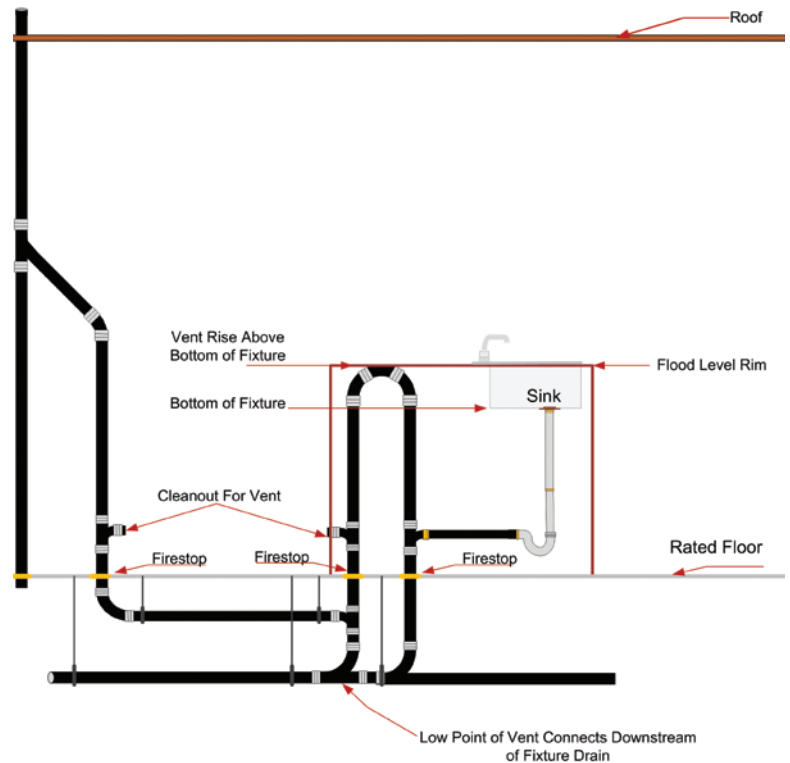

Island Fixture Vent

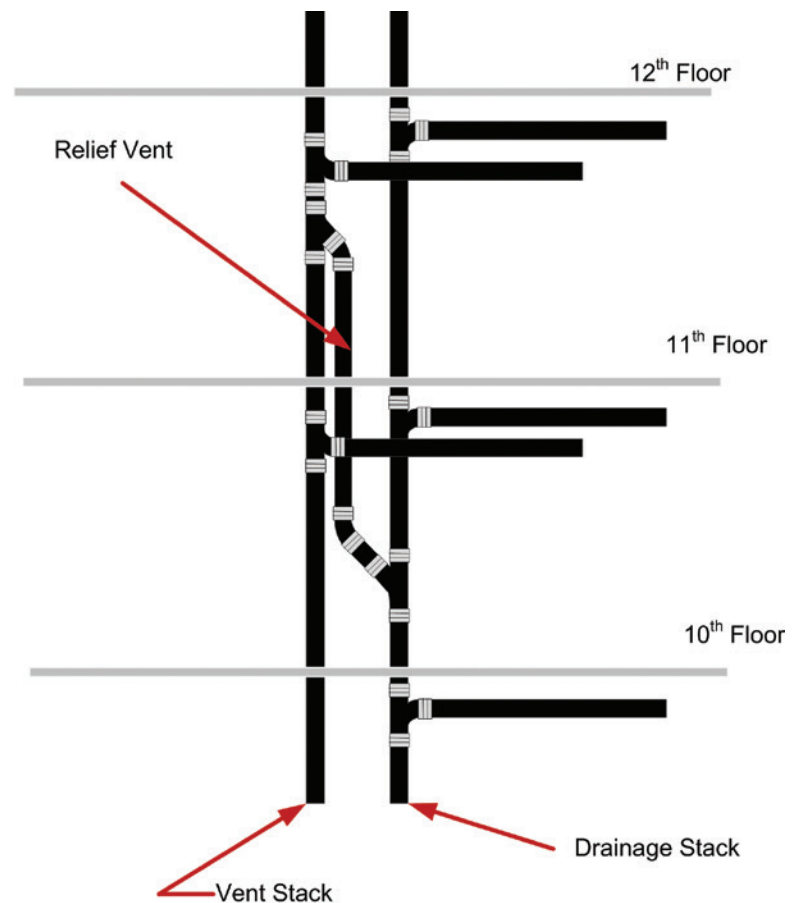

The graphic illustrates a relief vent connection.

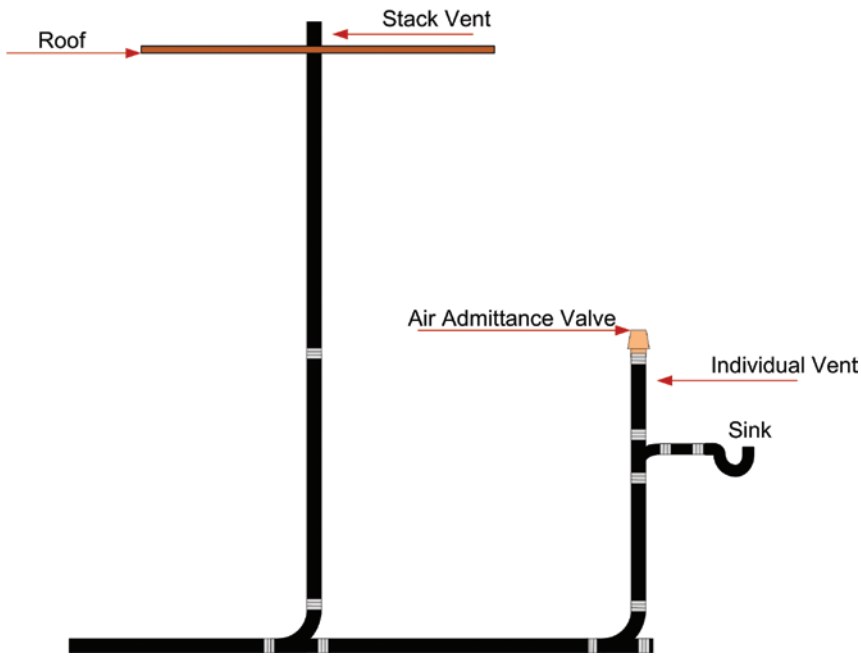

Air Admittance—Individual Vent

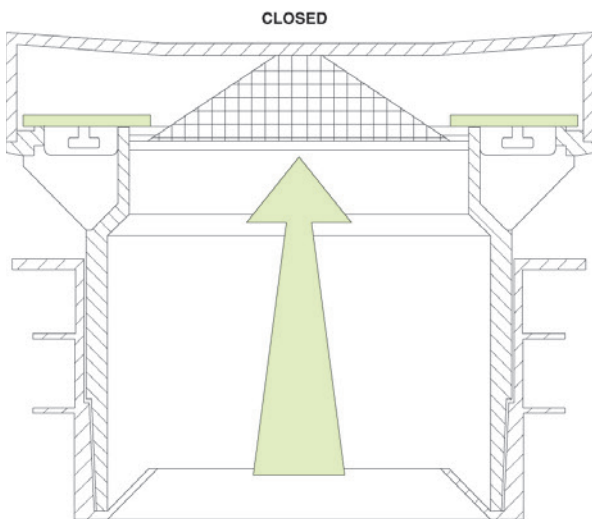

Air admittance valve closes and seals under zero or positive pressures



Studor ChemVent Air Admittance Valve (Courtesy of IPS)

the horizontal branch that serves the floor level within the branch interval required to have the relief vent. The location of this connection is intended to allow waste that might get into the relief vent, including condensation, to reach a waste line. This connection is made using a wye fitting installed as a drainage fitting in order to not impair the flow. The upper connection of the relief vent is made to the vent stack and is to be located a minimum of 3 feet (914 mm) above the floor level of the same horizontal branch. This connection is made using a wye fitting installed in an inverted position. The required 3-foot (914 mm) minimum height required is a common theme in Chapter 9 and is intended to prevent waste flow from entering the vent stack.

Air Admittance Valves

The air-admittance valve (AAV) is a device designed to allow air to enter the drainage system to balance the pressure and prevent siphonage of the water trap when negative pressure develops in the system. In this way, it is used on individual vents, branch vents and circuit vents in lieu of terminating vents to the exterior of the structure. Stack vents and vent stacks are permitted to terminate to a stack-type air admittance valve. The exception is for stack vents or vent stacks that serve drainage stacks exceeding six branch intervals.

Because the AAV will not provide relief of positive pressures, there are certain installation requirements that are specified in the IPC to relieve positive pressure. The one open pipe vent

required on every building drainage system in Section 918.7, Vent Required, and Section 903.1, Roof Extension, mandates that at least one vent pipe shall extend to the outdoors to relieve the system's positive pressure. Section 918.3.1 contains measures for pressure relief by requiring the installation of a relief vent where the horizontal branch is located more than four branch intervals from the top of the stack.

American Society of Sanitary Engineers (ASSE) has recently developed ANSI/ASSE Standard 1049—*Performance Requirements for Individual and Branch Type Air Admittance Valves for Chemical Waste Systems*. Air Admittance Valves (AAV) that are in compliance with ANSI/ASSE 1049 and meet the requirements of Section 702.5 and tested to ASTM F1412 for chemical resistance are now allowed to serve as the vent for non-neutralized special waste systems as an option to chemical waste vent piping terminating outdoors. It is quite common to see laboratory sinks that receive chemical waste located in islands in the

middle of rooms. To vent the system for these sinks using vent piping that can only terminate outdoors requires extensive labor and material. The use of the AAV's will significantly reduce the cost of plumbing these laboratories.

Air admittance valves shall not be located in spaces utilized as supply or return air plenums. In these locations, the negative or positive pressure conditions could adversely affect the valves operation.

Air admittance valves without an engineered design shall not be utilized to vent sumps or tanks of any type. The illustration below shows an example of one manufacturer's engineered design for use of an air admittance valve on a sump. This design allows for positive pressure relief.

Air admittance valves shall not be installed on outdoor vent terminals for the sole purpose of reducing clearances to gravity air intakes or mechanical intakes.

The installation of air admittance valves must conform to the requirements of Section 918.3 through 918.8 and the manufacturer's instructions. Where differences occur between the provisions of the code and the manufacturer's instructions, the most restrictive provisions must be applied.

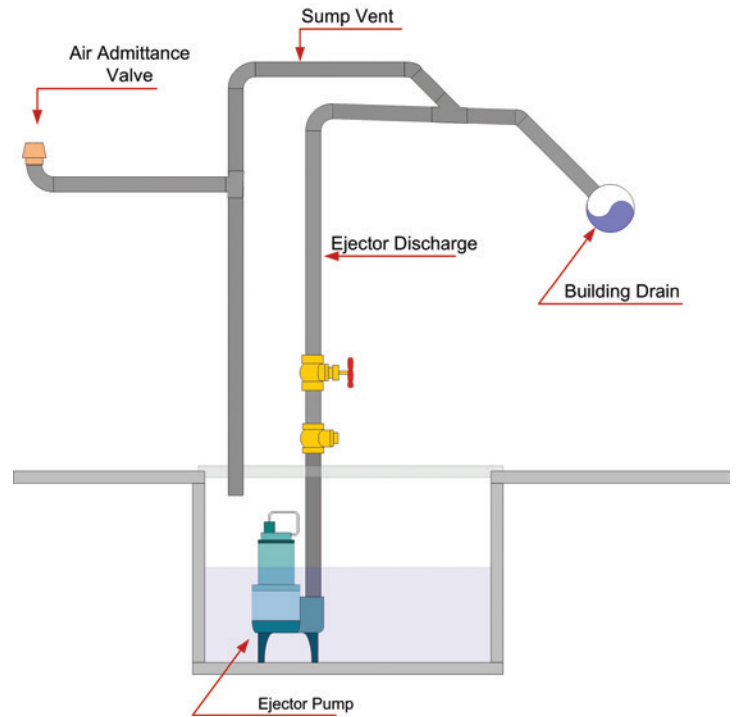

The graphic is an example of an engineered design

Engineered Vent Systems

This type of venting system is considered to be an alternative engineered design. Notice that according to **Table 919.2**, which provides criteria for determining cubic feet or air flow per minute for various diameters of pipe, a vent can be as small as ½ inch in diameter.

After the individual vent airflow rate is determined by the equation in Section 919.2, the size and developed length are determined by **Table 919.2**. The values in the table indicate the maximum developed length for a given pipe size and the individual vent airflow rate. Note that the engineered vent system must be designed, signed and sealed by a registered design professional and will need to be submitted for review by the code official in accordance with Section 105.3 of the IPC.

TABLE 919.2
Minimum Diameter and Maximum Length of Individual Branch
Fixture Vents and Individual Fixture Header Vents for Smooth Pipes

DIAMETER OF VENT PIPE (inches)	INDIVIDUAL VENT AIRFLOW RATE (cubic feet per minute)																			
	Maximum developed length of vent (feet)																			
	1	2	3	4	5	6	7	8	9	10	11	12	13	14	15	16	17	18	19	20
½	95	25	13	8	5	4	3	2	1	1	1	1	1	1	1	1	1	1	1	1
¾	100	88	47	30	20	15	10	9	7	6	5	4	3	3	3	2	2	2	2	1
1			100		65	48	37	29	24	20	17	14	12	11	9	8	7	7	6	6
1¼								100		73	62	53		40		32	29	26	23	21
1½												100	96		75	65	60	54	49	45
2																				100

For SI: 1 inch = 25.4 mm, 1 cubic foot per minute = 0.4719 L/s, 1 foot = 304.8 mm.



The arteries of civilization reach for the skies

Common Vent

This very simple concept allows two traps to be vented by the same vent. The two traps and their fixture drains can be either at the same level or at different levels, provided that they are on the same floor. The following diagrams show some of the various approaches to common venting. The sizing of common venting is specified in **Table 911.3**.

TABLE 911.3
Common Vent Size

Pipe Size (inches)	Maximum Discharge From Upper Fixture Drain (dfu)
1½	1
2	4
2½ to 3	6

For SI: 1 inch = 25.4 mm.

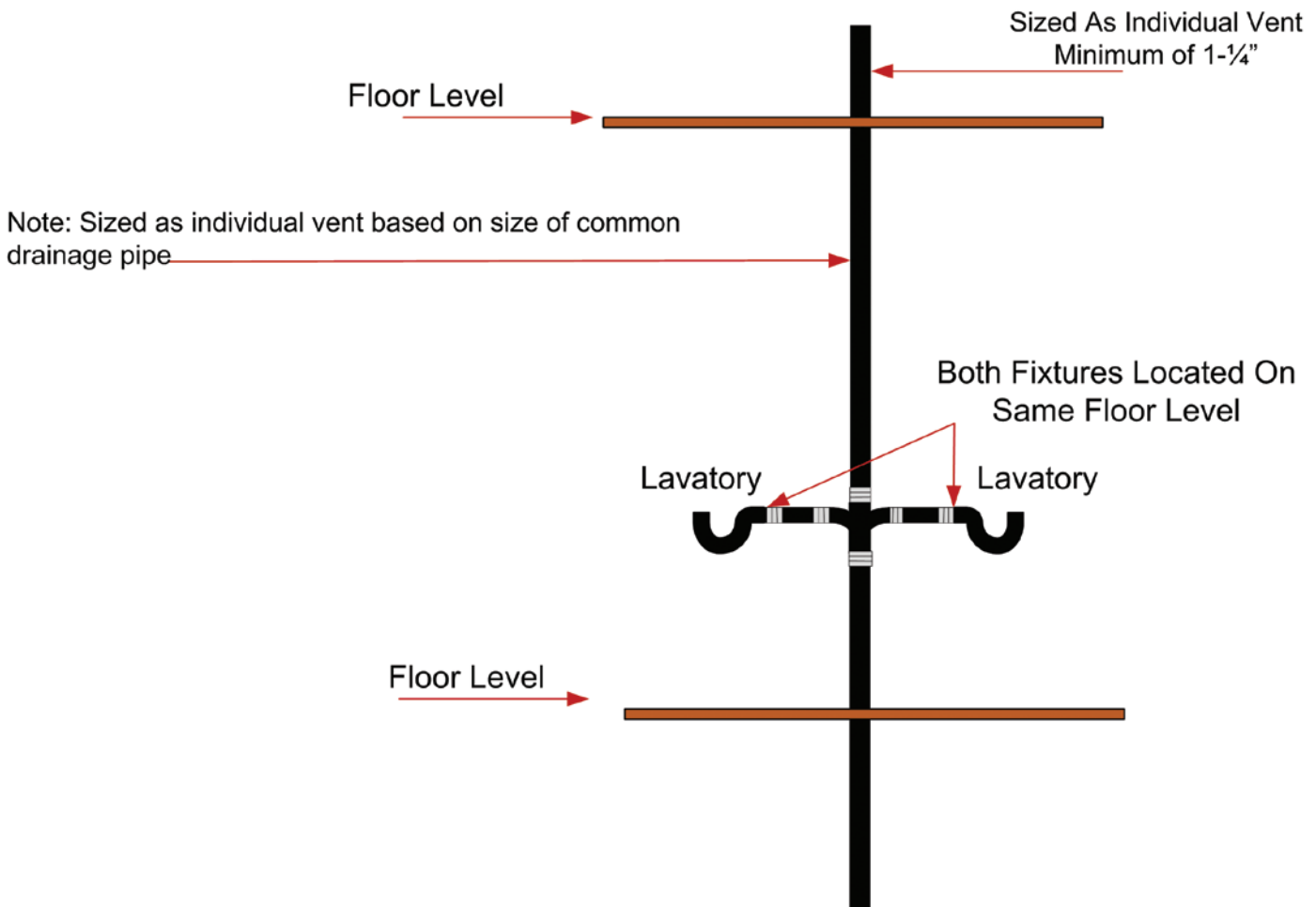

Common Vent with Fixture Drains Connecting at Same Level

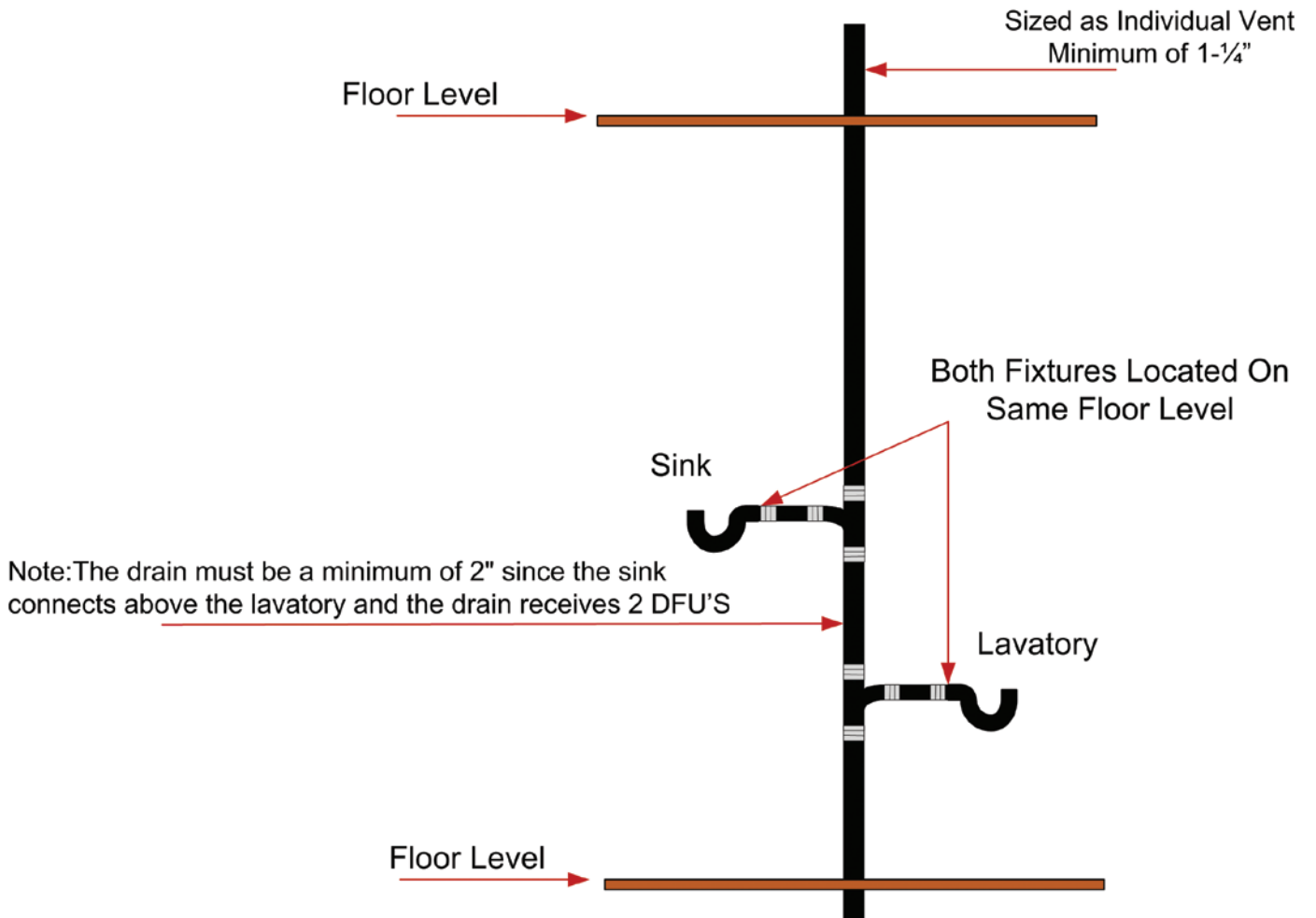
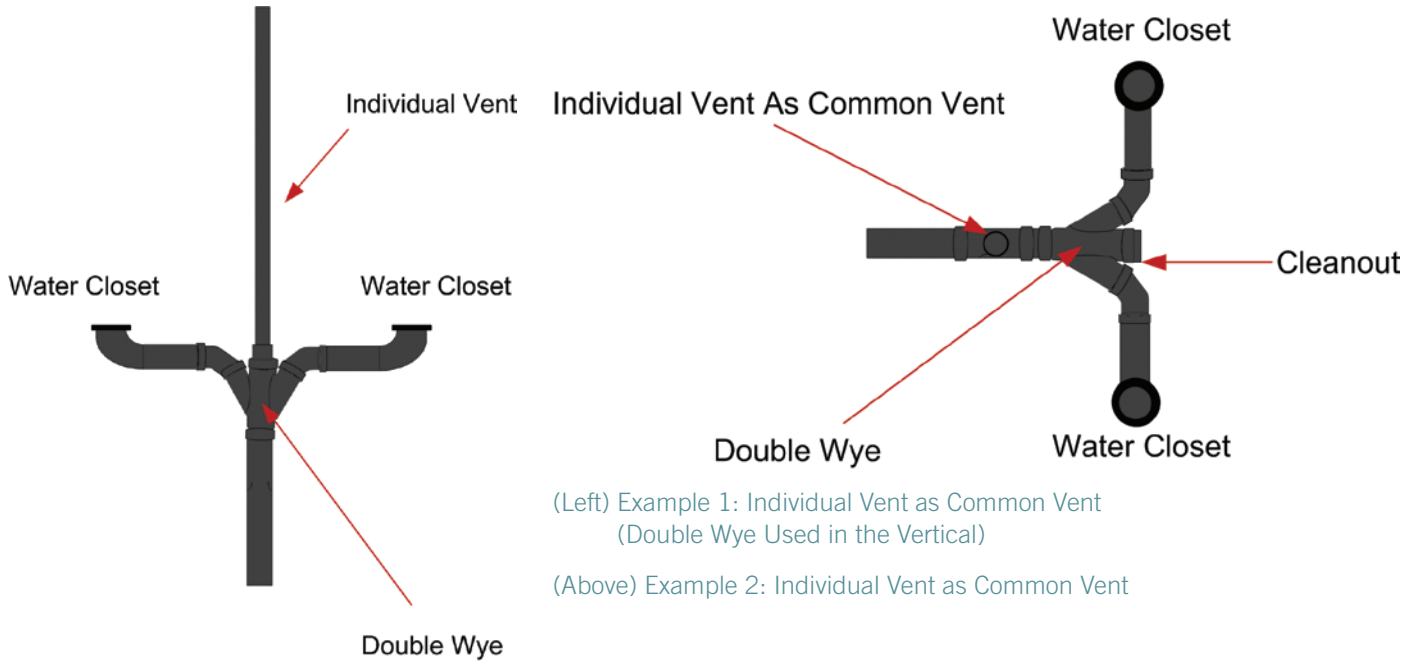

Example 3: Individual Vent based on size of Common Drainage Vent

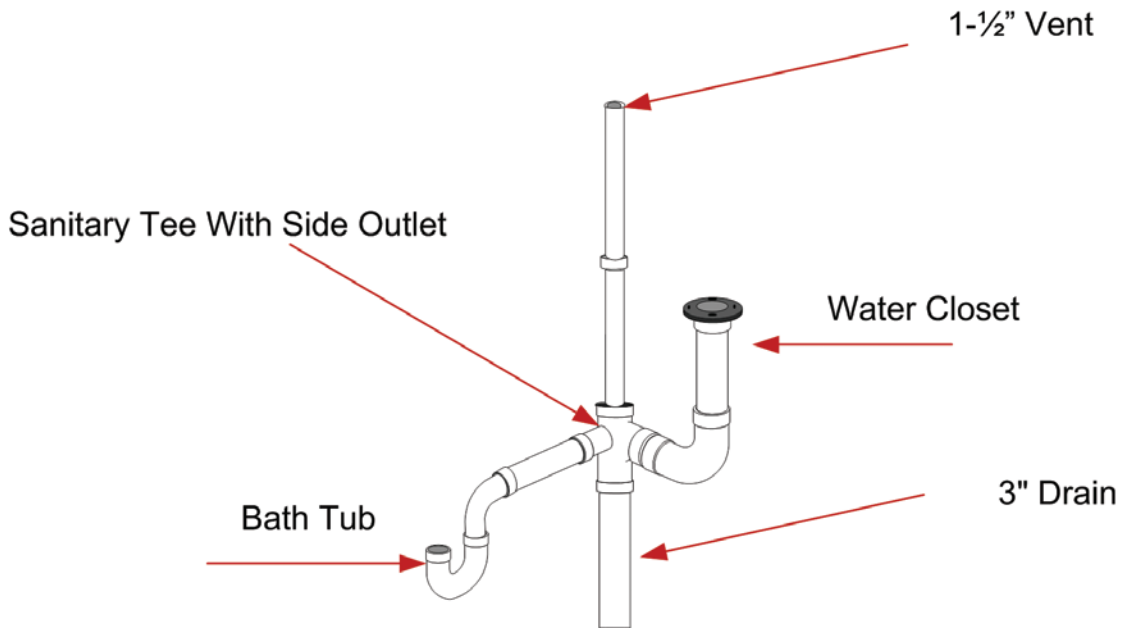

Common Vents with Fixture Drains Connecting at Same Level

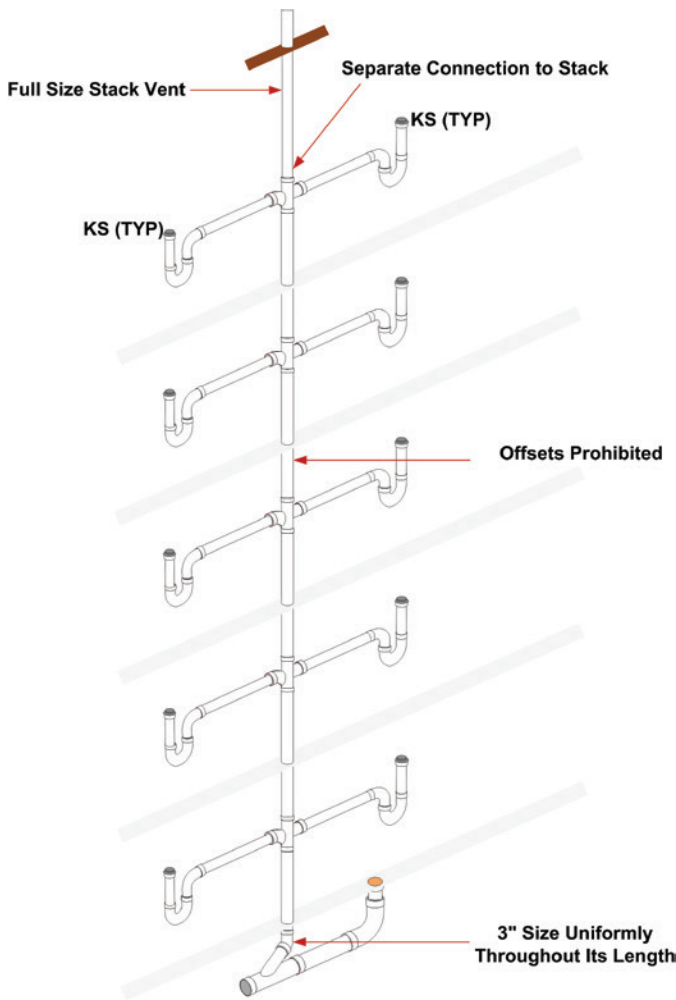

Waste Stack Vent

Waste Stack Vent

This is a very simple method of allowing a drainage stack to serve as a vent. It greatly extends the concept of a vertical common vent, except for some specific guidelines for installation. For this system to function effectively there cannot be any offsets in the waste stack portion. Once the highest branch interval is connected to the stack, the vent portion may contain offsets, provided such offsets are at least 6 inches above the branch interval connection. The size of the waste stack vent is to be in accordance with **Table 913.4**. Note for reference: the size of the stack, which is based on the total branch intervals, shall be maintained the same size from the lowest point of the stack to the vent termination or connection to another approved vent. In other words, if the fixture unit total would require a 3-inch-diameter (76 mm) drain per **Table 913.4**, then both the stack and its vent must be 3 inches (76 mm) in diameter with no offsets at all until at least 6 inches (152 mm) above the highest branch interval (see diagram).

These two methods of using the drain as a vent, common venting and waste stack venting, are, for the most part, vertical in their application. Now let's examine Wet Venting. This method is one of the three remaining methods of such venting that are more often found in a horizontal application.

Wet Venting

A fixture is said to be wet vented when it serves also to carry the discharge from fixtures connecting into the drainage system at a higher level. The use of wet venting reduces the number of individual vent pipes required by a plumbing drainage system as contrasted with the number required by a conventional system and hence reducing the cost of the venting system. There are many types of venting schemes and methods allowed in the *International Plumbing Code (IPC)*. The Horizontal Wet Venting method located in Section 912.1 of the IPC is one that we will discuss today.

What is a horizontal wet vent? A horizontal wet vent is a horizontal branch drain pipe that has been increased in size larger than what is normally required by Section 710. This increase in pipe size allows for a large air space above the maximum probable waste flow level in the pipe so as to provide for adequate venting airflow in the same pipe as the waste flow. Wet Venting as shown in **Figure 1** can be used in both vertical and horizontal applications.

The vertical method may be more common to plumbing installers in certain regions. However, don't be alarmed by what you see. The horizontal wet venting method is an effective way to provide a safe, sanitary system that can save the contractor and owner time and materials.

The fixture drain length from the wet vent is limited to the distances shown in **Table 909.1**. There may be a situation where the fixture location is at a distance that exceeds the maximum trap-to-vent distance. The code allows for any number of individual vented fixtures of the types allowed for a bathroom group to connect to the horizontal wet vent as long as the total number of fixtures allowed for the bathroom groups is not exceeded.

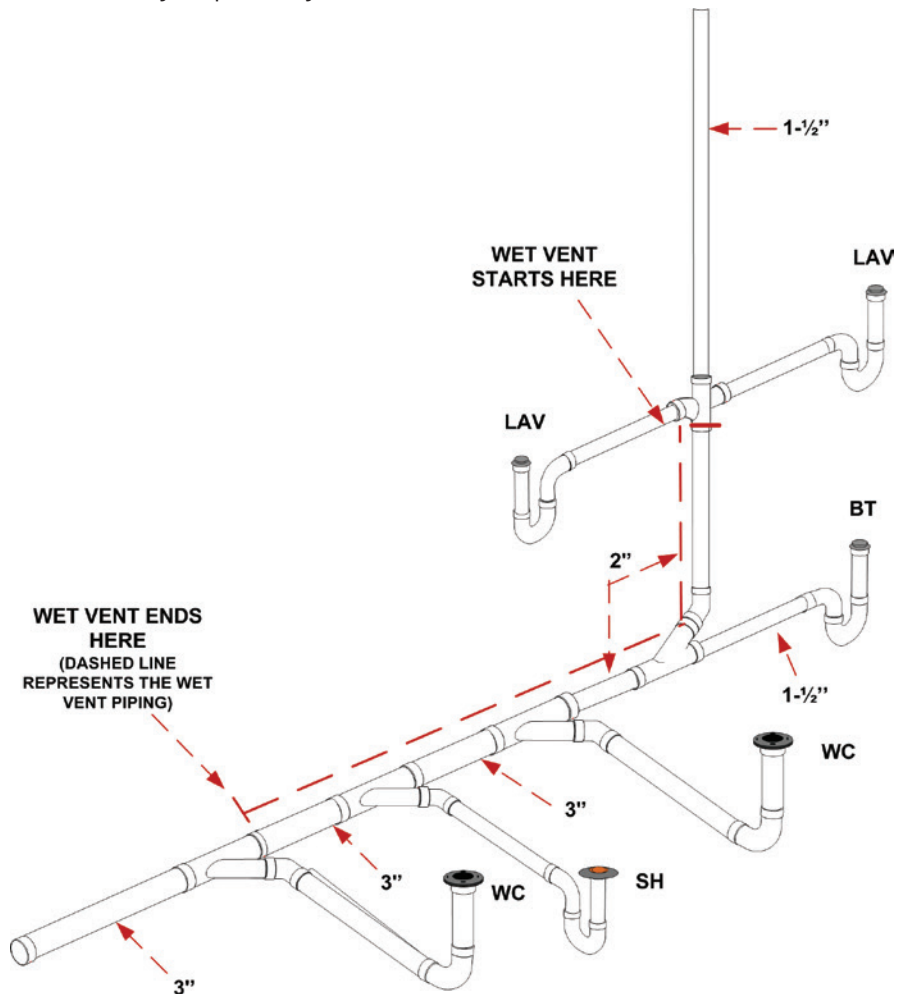

Figure 1: Horizontal Wet Venting Illustration

TABLE 909.1
Maximum Distance of Fixture Trap from Vent

Size of Trap (inches)	Slope (inch per foot)	Distance from Trap (feet)
1¼	¼	5
1½	¼	6
2	¼	8
3	⅛	12
4	⅛	16

For SI: 1 inch = 25.4 mm.

Section 202 of Chapter 2 is the key to the maximum number and type of fixtures that can be accommodated by a horizontal wet vent. The definition of Bathroom Group is a group of fixtures consisting of a water closet, lavatory, bathtub or shower, including or excluding a bidet, an emergency floor drain or both. Such fixtures are to be located together on the same floor level. This is done to avoid high flow velocities which could cause excessive turbulence that might block the air space above the waste flow level. Section 912.1 allows any combination of fixtures within two bathroom groups to be vented by a horizontal wet vent. A horizontal wet vent could have as few as two fixtures or as many as ten fixtures but not more than two fixtures of any type can be connected to the system. Each wet vented fixture drain shall connect independently to the horizontal wet vent. This is done to protect the function of each fixture, assuring that one fixture will not influence another's operation.

The dry vent, the vent that continues upward from the wet vent to the point of termination of connection to another vent, shall be either an individual vent or a common vent for any bathroom group fixture, except an emergency floor drain. Where the dry vent connects to a water closet fixture drain, the drain shall connect horizontally to the horizontal wet vent system. Not more than one wet vented fixture drain shall discharge upstream of the dry

vented fixture drain connection.

Vertical wet vented systems are required to have the water closets as the most downstream fixture. This is not the case in horizontal wet venting.

The dry vent must be sized in accordance with Section 906.2. Remember, though, that in this case, the drain served is going to be the entire wet vented section. It will need to be at least one-half the diameter of the largest section of pipe in the system. The wet-vented section itself is sized per **Table 912.3**. Keep in mind that any additional fixtures outside of the wet vent that are to be drained into the same branch must be connected to the branch downstream of the wet vent. Because the wet vent serves as a drain, the type of fittings used must be in accordance with the drainage pattern shown in Table 706.



IPC Venting Methods Save Resources and Lowers Cost While Protecting the Health of the Nation

**TABLE 912.3
Wet Vent Size**

Wet Vent Pipe Size (inches)	Drainage Fixture Load (dfu)
1½	1
2	4
2½	6
3	12

For SI: 1 inch=25.4 mm.

Circuit Venting

The *International Plumbing Code (IPC)* has a variety of methods that can be used to vent plumbing fixtures and traps. Circuit venting is one of these methods and it has been laboratory and field tested, establishing a long history of satisfactory service. Extensive research into the performance of circuit vented systems was conducted at the State University of Iowa. The research concluded that the single vent for the eight fixtures provided the necessary protection of the trap seal. Circuit venting was included in Roy B. Hunter's research at the National Bureau of Standards and reported in BMS 66. The venting method has long been recognized by the plumbing community and is included in the *American Society of Plumbing Engineers Data Book*. The principle of circuit venting is that the flow of drainage never exceeds a half-full flow condition. The air for venting the fixtures circulates in the top half of the horizontal branch drain pipe. The flow velocity in the horizontal branch is slow and non-turbulent, thereby preventing pressure differentials from affecting the connecting fixtures. The circuit-vented fixtures must connect to the circuit-vented branch in the horizontal plane to limit the amount of turbulence created by fixture discharge.

TABLE 909.1
Maximum Distance of Fixture Trap from Vent

Size of Trap (inches)	Slope (inch per foot)	Distance from Trap (feet)
1¼	¼	5
1½	¼	6
2	¼	8
3	⅛	12
4	⅛	16

For SI: 1 inch = 25.4 mm.

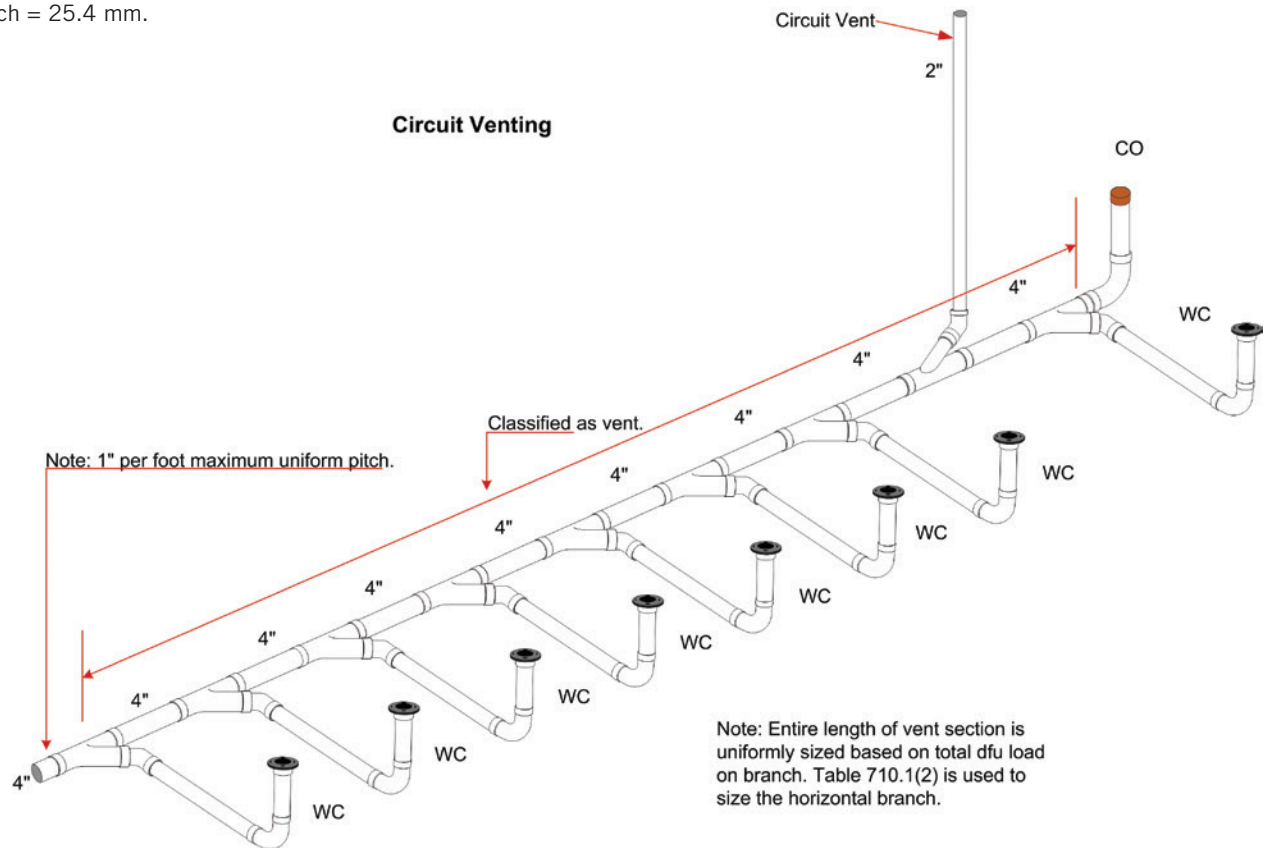

Sizing a Circuit Vent System

The Circuit Venting method is similar to wet venting except that it allows you to combine a total of eight fixtures on a single floor that are not limited to the two bathroom groups. It might be easier to explain by examining how circuit venting differs from wet venting. The fixture drains shall connect horizontally to the horizontal branch being circuit vented. Again, the fixture drains are limited in length to those shown in **Table 909.1**. Because circuit venting is only to be used on horizontal applications as opposed to wet venting, which can be both horizontal and vertical installations, the maximum slope for a circuit vent is 1 unit in 12 units horizontally, or 8-percent slope. The entire length of the circuit vent portion of the horizontal branch shall be sized for the total drainage discharge to the branch. There is not a unique sizing table for circuit venting as there is for wet venting or common venting.

The circuit vent connection must be located between the two uppermost fixture drains and shall connect to the horizontal branch. It cannot serve as a drain for other fixtures—it is truly a dry vent. Where a circuit vent consists of four or more water closets and discharges into a drainage stack that also receives the discharge of upper horizontal branches, a relief vent shall be connected to the horizontal branch ahead of the connection to the drainage stack and after the most downstream fixture drain of the circuit vent (see **Figure 2**).

Additional fixture drains may be connected with the circuit-vented branch, but they need

to be vented by means other than the circuit vent, and the fixture unit values would be added to the total fixture-unit discharge into the horizontal branch. Such fixtures must also be located on the same floor as the circuit vent to which they connect. Where the relief vent receives the discharge of other fixtures, the maximum discharge allowed is 4 drainage fixture units.

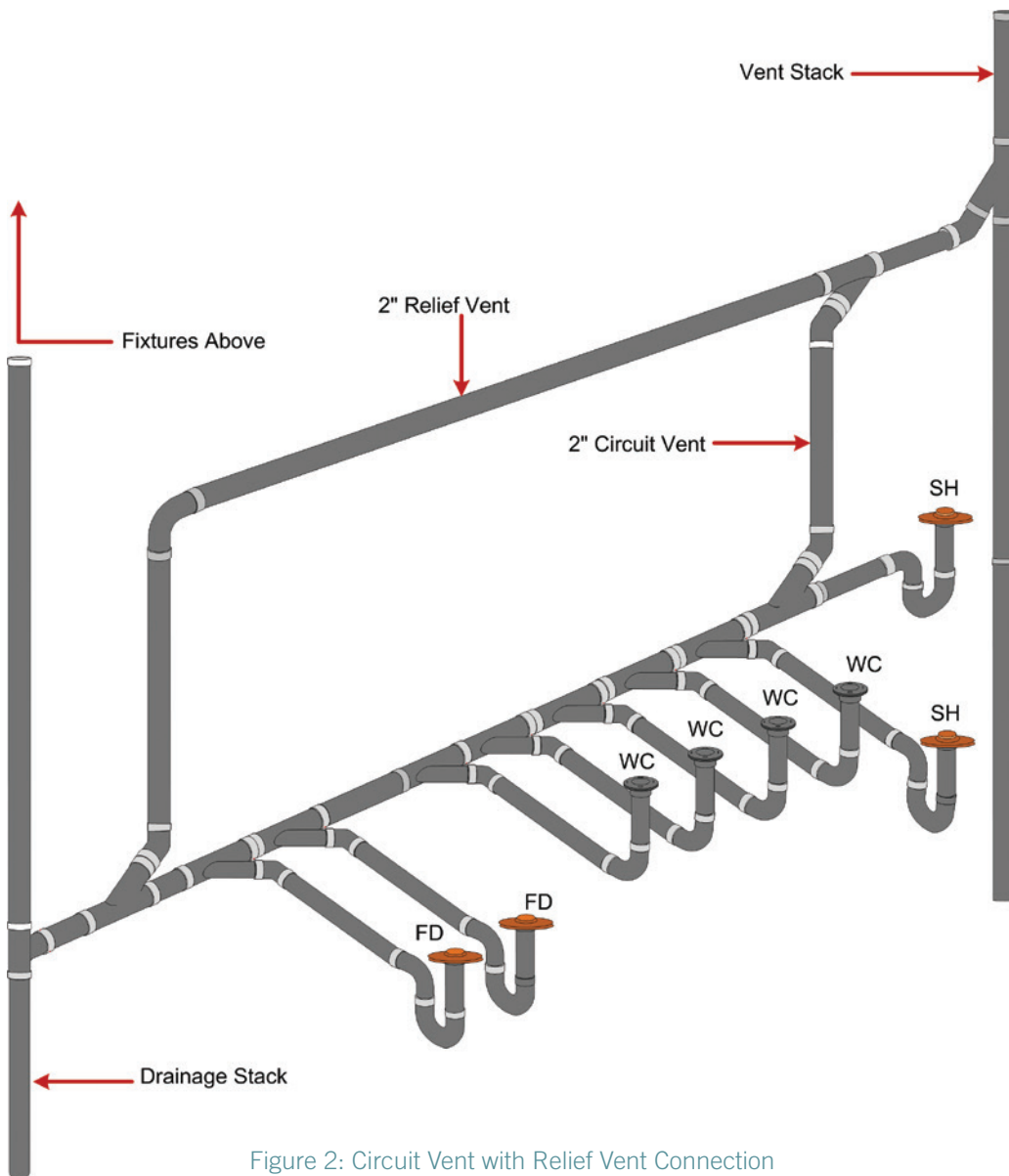

Figure 2: Circuit Vent with Relief Vent Connection

Combination Waste and Vent System

This system is based on the same premise as the circuit-vented system. Most plumbing codes place arbitrary restrictions on combination drain (waste) and vent systems because the system appears too good to be true. The performance of the combination waste and vent system was verified in tests conducted at the Stevens Institute of Technology. If sized according to **Table 915.2.2** in the IPC, the study concluded that the distance from a trap does not have to be limited in length. This is a horizontal wet vent system limited to floor drains, standpipes, sinks and lavatories for the purpose of venting, except that a vertical riser, not to exceed 8 feet in length, may be used to connect a fixture drain to the horizontal combination drain and vent system. Again, the idea here is that the top half of the horizontal drain acts as a vent. As long as both the horizontal drain and vent system and the maximum 8-foot riser to a fixture drain are sized in accordance with **Table 915.2.2**, the flow of free air will be sufficient for the propped design.

TABLE 915.2.2
Size of Combination Waste and Vent Pipe

Diameter Pipe (inches)	Maximum Number of Drainage Fixture Units (dfu)	
	Connection to a horizontal branch or stack	Connection to a building drain or building sub-drain
2	3	4
2½	6	26
3	12	31
4	20	50
5	160	250
6	360	575

For SI: 1 inch=25.4 mm.

Of course, to get that free flow of air, a vent to the atmosphere must be provided. The vent, which must be sized for the total drainage fixture load of the combination drain and vent system per Section 906.2, can be located anywhere on the system and must rise vertically at least 6 inches before offsetting. This type of system is unique in that a branch that is already vented can accept a fixture drain under this combination drain and vent method (see **Figure 3**). Remember, too, that this type of venting procedure is dependent on adequate sizing and maintaining a horizontal installation. For this reason, the horizontal portion must not exceed a slope of one-half unit vertical in 12 units horizontal, or 4-percent slope. The horizontal length of a combination waste and vent system shall be unlimited.

Note: 1-½" vent allowed if the run of the vent piping is 40' or less

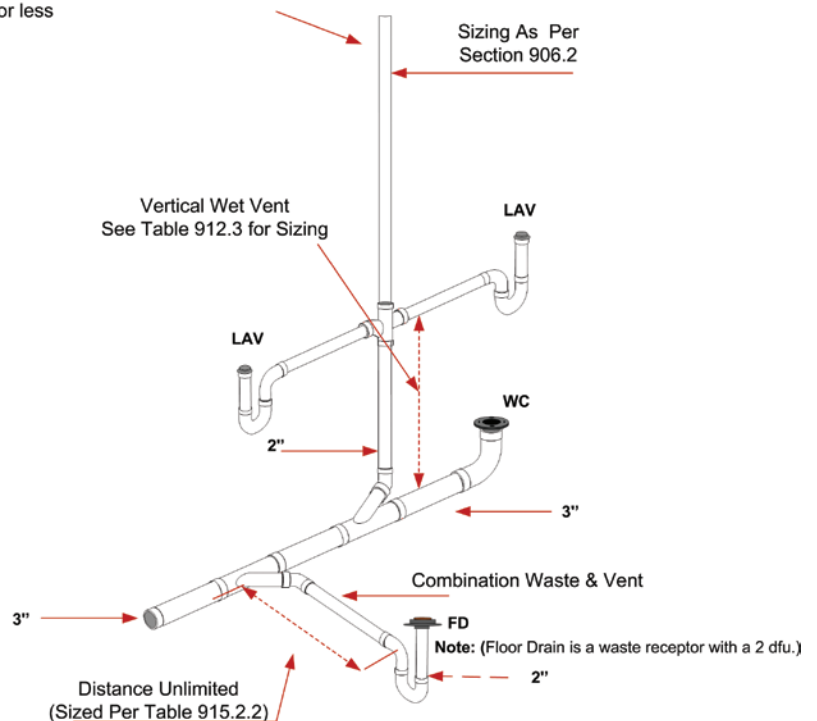
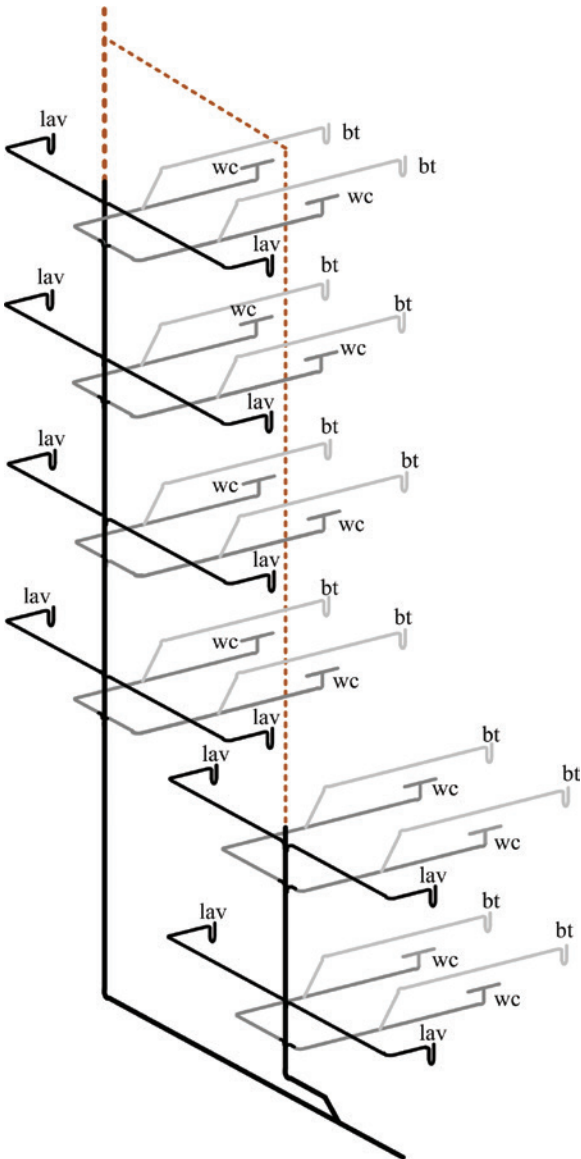

Figure 3

The IPC continues to emphasize both prescriptive- and performance-related provisions. A proven venting system method was added in the 2012 IPC that now compliments the most extensive collection of venting options in the world.

Single Stack Vent System

The Single Stack Vent System was introduced into the IPC in the 2012 Edition and is based on a drainage stack system in the City of Philadelphia (Pennsylvania) Plumbing Code which has been used successfully in many multi-story and high-rise buildings for over 100 years. The Philadelphia System is described in Volume 2, Chapter 3 of the American Society of Plumbing Engineers (ASPE) Data Book. The Philadelphia or ‘one pipe’ system refers to the use of one drainage stack instead of having separate drainage and vent stacks. The Philadelphia system successfully utilizes “S” traps for fixture traps located above the floor and within a specified distance from the stack. However, because the IPC prohibits the use of S traps, the Single Stack Vent System in the IPC utilizes an oversized vertical pipe from its connection at the end of the fixture trap’s fixture drain (also known by some tradesmen as a ‘trap arm’) to the horizontal drainage piping of the system. This is the same concept utilized in combination waste and vent systems for fixtures that are located above the floor. The oversized vertical pipe eliminates any possibility of siphoning of a fixture trap as the waste volume entering the vertical pipe could not possibly block the venting air space in the vertical pipe.



Single Stack System for a Six Story Building

In a Single Stack Vent System the drainage stack serves as both a single-stack drainage and vent system. The drainage stack and branch piping are considered as vents for the drainage system as a whole. Pipe sizing in a single stack drainage system is larger than in a conventional one, however a significant cost saving is achieved by the reduction of the vent piping needed. This venting system serves as a viable alternative to the more traditional systems that are being used. The length of trap arms is limited and the vertical drop from the fixtures is oversized also. Fixture connections that do not meet the requirement for a single stack system must be conventionally vented. The length of the trap arm is limited to reduce any suction buildup, and the stack is oversized to limit the internal air pressure and vacuum build up. Stacks greater than two branch intervals in height are prohibited from receiving the discharge of horizontal branches on the lower two floors. The separate stack serving the lower two floors, is required to connect to the building drain at a distance of not less than 10 pipe diameters downstream from the base of the connection of the single stack vented system. This proven method has been laboratory tested to determine sizing and installation requirements that provide proper venting to the drainage system.

The size of a single stack drainage stack is based upon the height and the total number of dfu connected to the stack. **Table 917.2** provides the stack dfu limitations according to stack height. The height of the stack is from the connection to the building drain to the uppermost drainage connection to the stack. Drainage stacks must be the same size from the base to the termination of the stack to the outdoors. The requirement for the stack vent to be the same size as the drainage stack allows the stack vent to be of any length on its path to its termination point outdoors.

For a 3-inch (76 mm) stack, there is a limitation of two water closets on the stack. This limits the amount of solids in this small diameter stack so that airflow is not impeded.

TABLE 917.2
Single Stack Size

Stack Size (inches)	Maximum Connected Drainage Fixture Units		
	Stacks less than 75 feet in height	Stacks 75 feet to less than 160 feet in height	Stacks 160 feet and greater in height
3	24	NP	NP
4	225	24	NP
5	480	225	24
6	1,015	480	225
8	2,320	1,015	480
10	4,500	2,320	1,015
12	8,100	4,500	2,320
15	13,600	8,100	4,500

For SI: 1 inch=25.4 mm, 1 foot=304.8 mm.

Table 917.2 is used simply by identifying the column that includes the height of the stack and then reading down that column to identify the row that has a dfu value that meets or exceeds the total dfu load on the stack. Once the row is identified, the user will find the stack size required from the first left-hand column. For example, the total load on the stack is 1000 dfu and the height of the stack is 150 feet (45,720 mm), the third column from the left is chosen and the row for an 8-inch (203 mm) stack size is identified. The “NP” in the table means not possible.

The sizing of the horizontal branches that connect to the stack is according to Table 710.1(2). Only the first and second columns of this table are to be used for sizing. The remaining columns of the table covering stacks have no relationship to this section. For example, if a horizontal branch is required to carry 170 dfu, then a 5-inch (127 mm) horizontal branch is required.

A 3-inch (76 mm) horizontal branch with a water closet located within 18 inches (457 mm) horizontal developed length of the stack has special limitations. If a water closet is located within 18 inches (457 mm) of the horizontal developed length of the stack and the connection is not made with a sanitary tee, then the only fixture that can be served by that horizontal branch is that water closet. If the connection to the stack of a 3-inch (76 mm) horizontal branch serving a single water closet is made using a sanitary tee, then one fixture having a 1½-inch drain can also be connected to the 3-inch (76 mm) horizontal branch.

Where a horizontal branch connects to the stack through a wye connection and the branch carries the discharge of one or more water closets, the water closet must be not more than 4 feet (1219 mm) in horizontal developed length from the stack. If the connection at the stack is made with a sanitary tee, the distance limitation is extended to 8 feet (2438 mm) in horizontal developed length.

Section 917.5 specifies the minimum sizes for the vertical portions of the fixture drains (other than water closets), that are connected to horizontal branches. Vertical sections of the fixture drains are required for fixtures such as lavatories, wall hung urinals, and standard pipes with traps above the horizontal branch. The minimum size for any vertical section of fixture drain is 2 inches (51 mm), except where standpipes and water-supplied urinals have vertical sections of fixture drains, then the vertical section must be 3 inches (76 mm). If the vertical sections of the fixture drains cannot be of these minimum sizes, then the fixture drains must be vented by a method other than the single stack method.

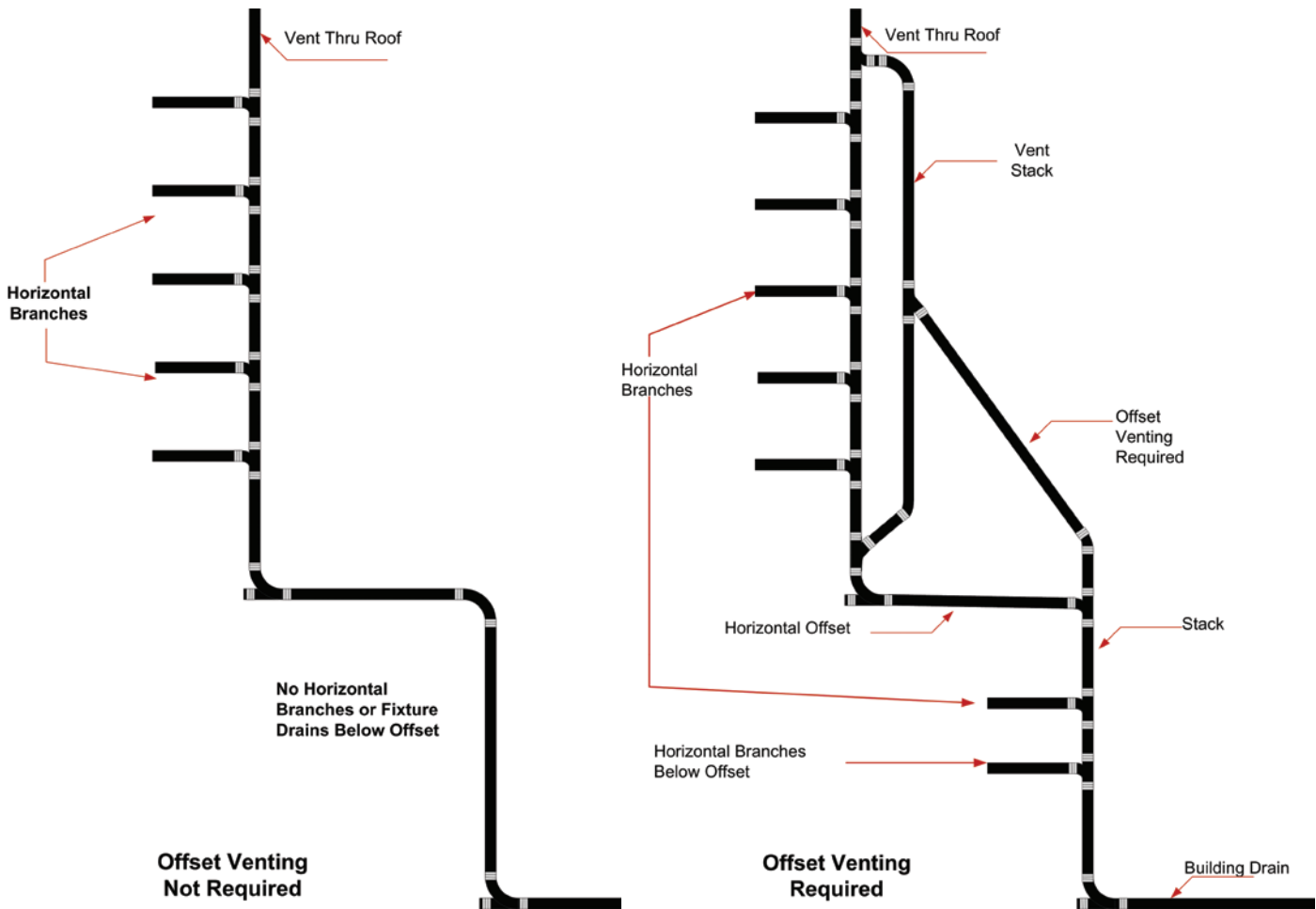

Offset venting requirement for single stack vent system.

The height of the vertical section must not be greater than 4 feet (1219 mm). If the height is greater than 4 feet (1219 mm), then the fixture requires venting by a method other than the single stack method. In most situations, fixtures will not be greater than 4 feet (1219 mm) above the horizontal branch so additional venting methods are typically not required.

In arrangements where a horizontal branch carries the discharge of two or more water closets and the horizontal developed length of other fixtures discharging to the horizontal branch exceeds the limitations of Section 917.4, then those fixtures (other than water closets) located beyond the developed length limitation require venting by a method other than the single stack method. Section 917.6 indicates all of the types of venting that can be used for this purpose.

Section 917.7 addresses horizontal offsets in a single stack vent system. Where horizontal branches or fixture drains connect below a horizontal offset of a stack, the offset requires venting in accordance with Section 907.

Fixture drain connections to the stack must be made in the area of the stack that is 2 feet (610 mm) above or below the horizontal offset. Where there are no fixtures below the horizontal offset, the offset does not require venting. The total number of dfu coming from the stack is used to size the building drain and building sewer in accordance with Table 710.1(1).

Many experienced plumbers and Inspectors will agree that the venting requirements of a plumbing system are usually the most difficult to comprehend. The IPC contains more types of venting methods than are shown in other plumbing codes. As you continue to examine various methodologies, you will begin to see how they provide viable alternatives to “typical” venting options.



NOT A MEMBER?

ICC is committed to supporting the work you do by keeping you connected to the best Member benefits, services and I-Code resources available.

www.iccsafe.org/pmgmem

GET INVOLVED!

Check out the PMG Membership Council for the latest plumbing code support documents and find out how you can get involved in the plumbing, mechanical, fuel gas, and swimming pool community and influence the direction of ICC.

www.iccsafe.org/pmgcouncil



For More Information: Contact Lee Clifton, Director of PMG Resources, Government Relations
lclifton@iccsafe.org | www.iccsafe.org/pmgcouncil

